

ESEMPI DI COMPONENTABILITA'

examples of compositions

RECEPTION LINEARE SINGOLA
single linear reception

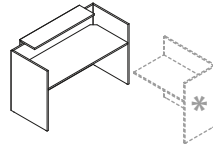

ART.013+045

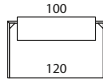

ART.014+045

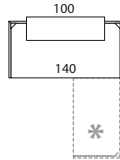

ART.019+046

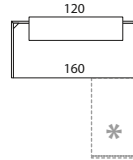

ART.020+047

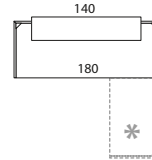

- VISTE IN PIANTA -
- Top view -

* = POSSIBILITA' DI UTILIZZO ALLUNGO RECEPTION DX O SX
= Possibility to use the right or left extension reception

RECEPTION LINEARE DOPPIA
double linear reception

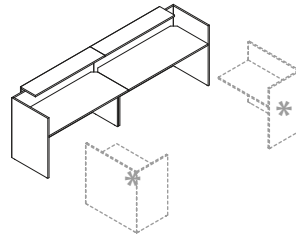

1 ART.022 + 2 ART.045

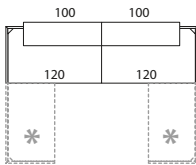

1 ART.023 + 2 ART.046

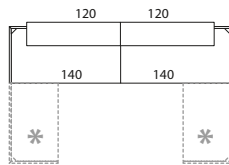

1 ART.024 + 2 ART.047

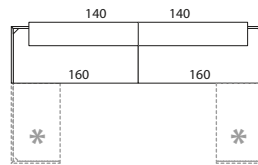

1 ART.025 + 2 ART.048

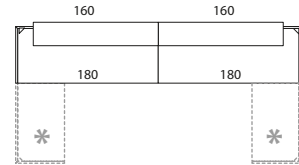

RECEPTION LINEARE CON MODULO PROLUNGA CENTRALE
linear reception with central module

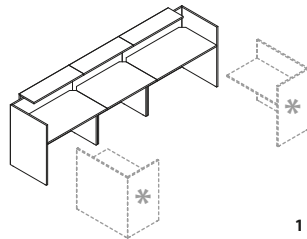

1 ART.022 + 1 ART.027 + 3 ART.045

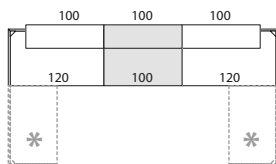

1 ART.023 + 1 ART.027 + 1 ART.045 + 2 ART.046

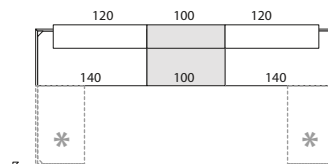

1 ART.024 + 1 ART.027 + 1 ART.045 + 2 ART.047

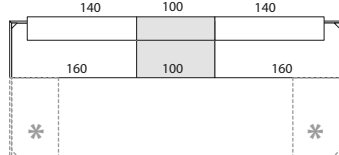

1 ART.025 + 1 ART.027 + 1 ART.045 + 2 ART.048

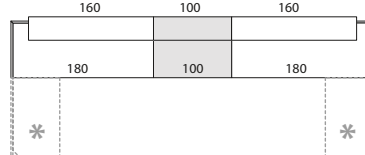

ESEMPI DI COMPONENTABILITA'

examples of compositions

RECEPTION TERMINALI
CON ANGOLO, PROLUNGA CENTRALE E MODULI CONVERSAZIONE
terminal reception with corner, central module and conversation modules

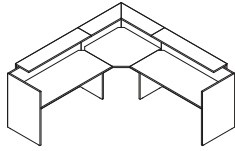

ART.054-055-056-057+
ART.045-046-047-048+
LED ART.060-061-062-063

ART.049+
ART.066+
LED ART.064

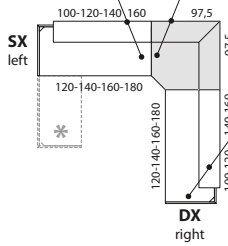

ART.050-051-052-053+
ART.045-046-047-048+
LED ART.060-061-062-063

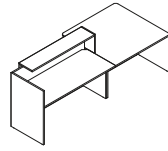

ART.054-055-056-057+
ART.045-046-047-048+
LED ART.060-061-062-063

ART.058-069

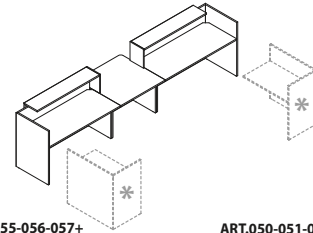
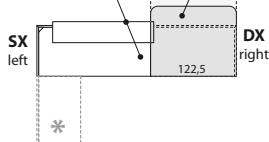

ART.054-055-056-057+
ART.045-046-047-048+
LED ART.060-061-062-063

ART.028

ART.050-051-052-053+
ART.045-046-047-048+
LED ART.060-061-062-063

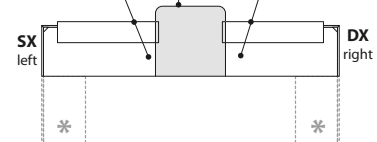

* = SU TUTTE LE RECEPTION TERMINALI C'E
POSSIBILITA' DI UTILIZZO ALLUNGO RECEPTION DX O SX
= Possibility to use the right or left extension with
all terminal reception

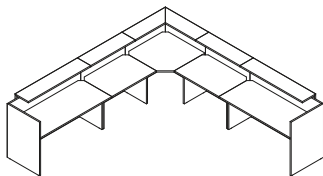

ART.054-055-056-057+
ART.045-046-047-048+
LED ART.060-061-062-063

ART.027+
ART.045+
LED ART.060

ART.049+
ART.066+
LED ART.064

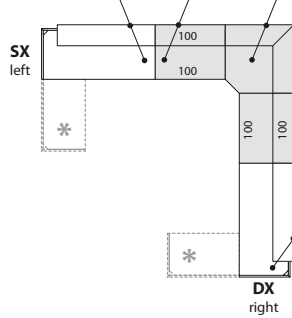

ART.050-051-052-053+
ART.045-046-047-048+
LED ART.060-061-062-063

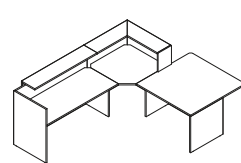

ART.054-055-056-057+
ART.045-046-047-048+
LED ART.060-061-062-063

ART.049+
ART.066+
LED ART.064

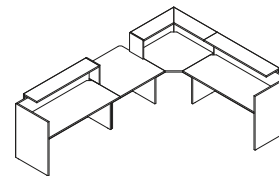
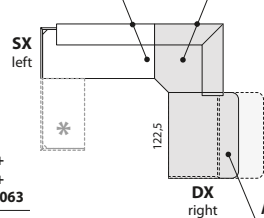

ART.054-055-056-057+
ART.045-046-047-048+
LED ART.060-061-062-063

ART.028

ART.049+
ART.066+
LED ART.064

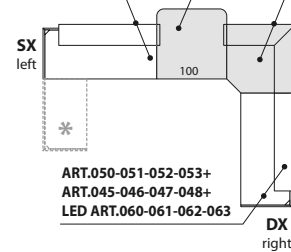

ART.050-051-052-053+
ART.045-046-047-048+
LED ART.060-061-062-063

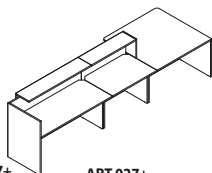

ART.054-055-056-057+
ART.045-046-047-048+
LED ART.060-061-062-063

ART.027+
ART.045+
LED ART.060

ART.058-069

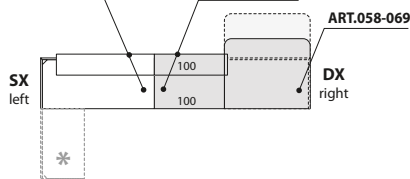

ART.054-055-056-057+
ART.045-046-047-048+
LED ART.060-061-062-063

ART.049+
ART.066+
LED ART.064

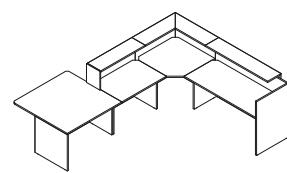
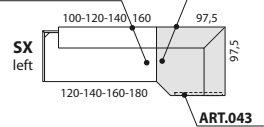

ART.059-070

ART.027+
ART.045+
LED ART.060

ART.049+
ART.066+
LED ART.064

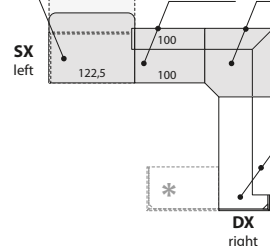

ART.050-051-052-053+
ART.045-046-047-048+
LED ART.060-061-062-063

DIMENSIONI
dimensions

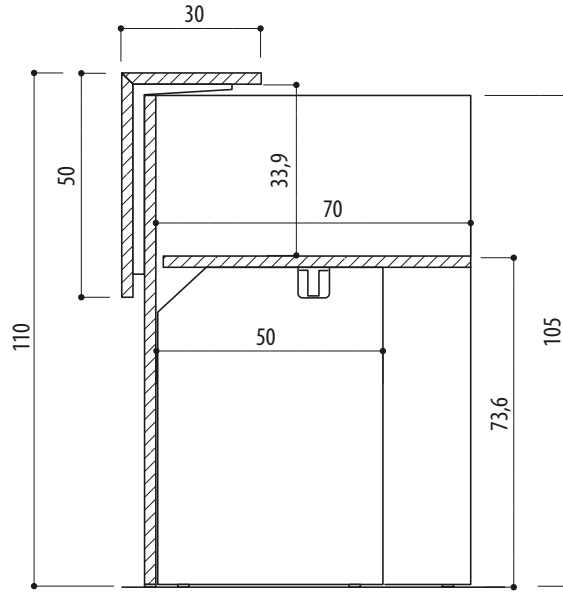

SEZIONE VERTICALE
MODULI RECEPTION
vertical section of
reception modules

Type your text

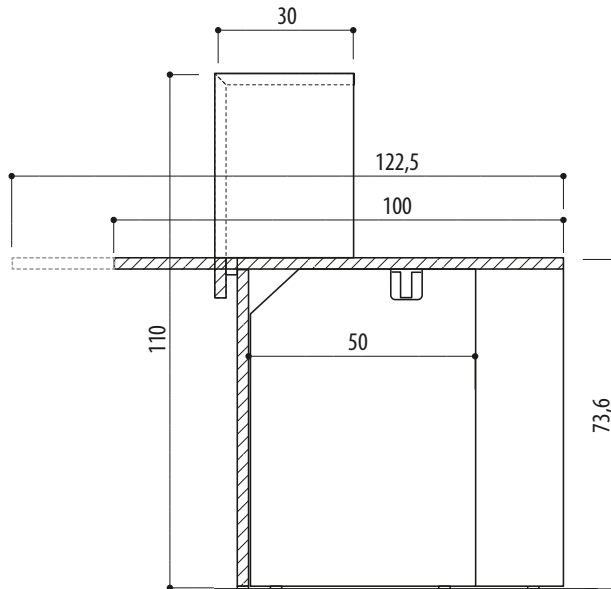

SEZIONE VERTICALE
MODULI CONVERSAZIONE
vertical section of
conversation modules

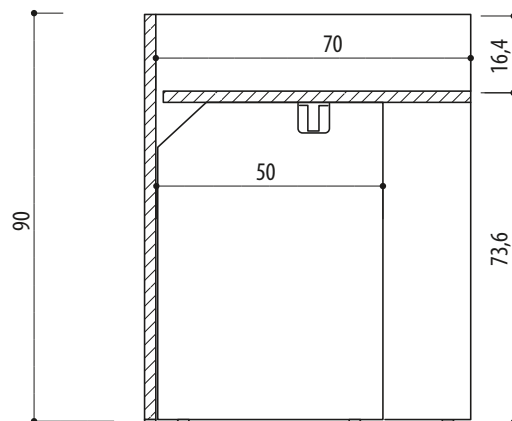

SEZIONE VERTICALE
CATTEDRE
vertical section of
conference desks